

1	Type	M6.5 Lens	
2	Resolution	8MP	
3	Image Format	1/3.2"	
4	Image Circle	φ6.05mm(MAX)	
5	EFL	4.22mm	
6	TTL	5.08mm	
7	F/NO.	2.4	
8	FFL (M)	1.38mm	
9	BFL (O)	1.42mm	
10	For Sensor	1/3.2"	
11	F.O.V	Horizontal	56.4°
12		Vertical	44.0°
13		Diagonal	68.1°
14	TV Distortion	<-1.5%	
15	Relative Ill.	>47%	
16	Chief Ray Angle	<27.3°	
17	M.O.D	0.1m~∞	
18	Mount Type	M6.5*P0.35	
19	Dimension Figure	φ6.5*L5.08mm	
20	Lens Structure	5P	
21	IR-Filter	Non-IR	
22	Waterproof	---	
23	Weight	---	
24	Iris Operation	Fixed	
25	Zoom Operation	Fixed	
26	Focus Operation	Manual	
27	Operating Temperature	-15° ~+45°	
28	Storage Temperature	-15° ~+45°	

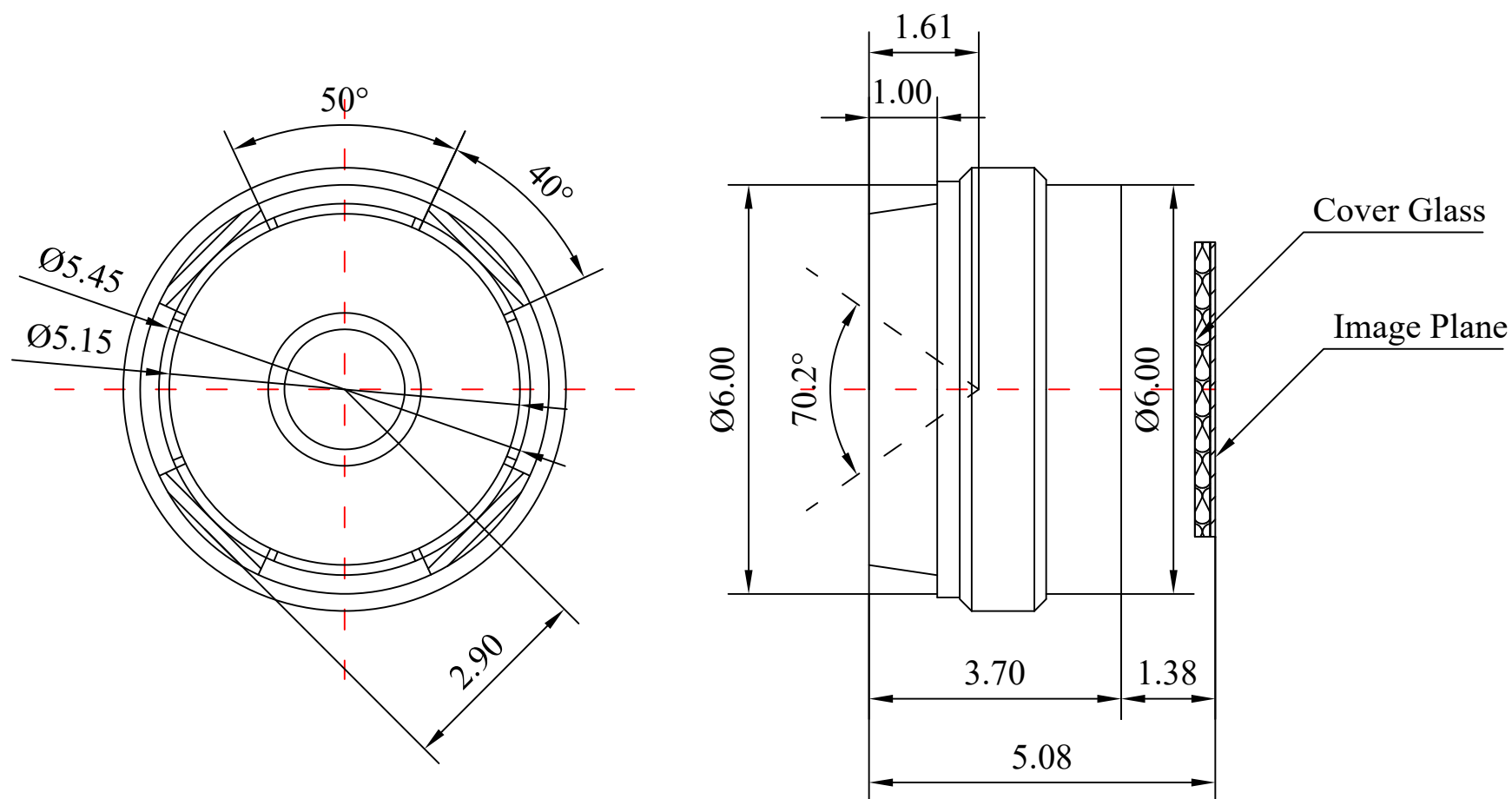
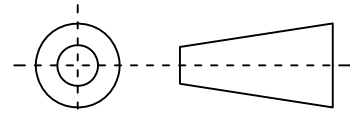

Scale	Remark	Tolerances	Date	Revised		福州创安光电科技有限公司 FUZHOU CHUANGAN OPTICS CO., LTD
4:1	X	±0.2	2021-10-11	CH2020A Rev1.0		
	X.0	±0.15				
Units	X.00	±0.10	Design	Linda	2021-07-03	 3D Angle Projection
	X.000	±0.001	Checked	Anna	2021-07-09	
mm	Angle	±0.5°	Approval	Sanmu	2021-07-12	